

# BPS CLIMA®

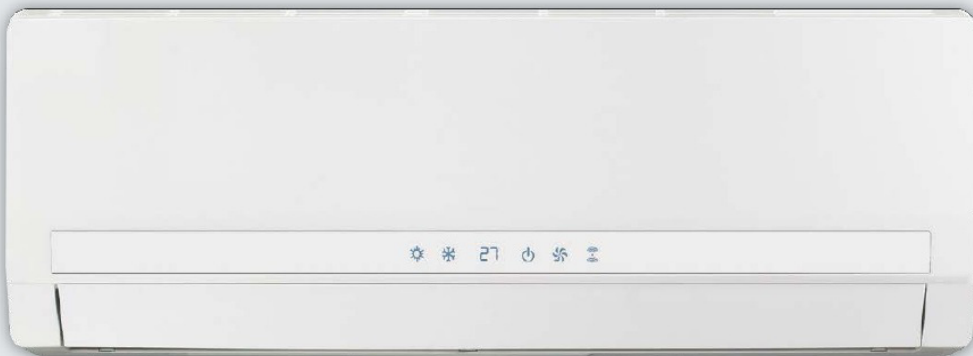
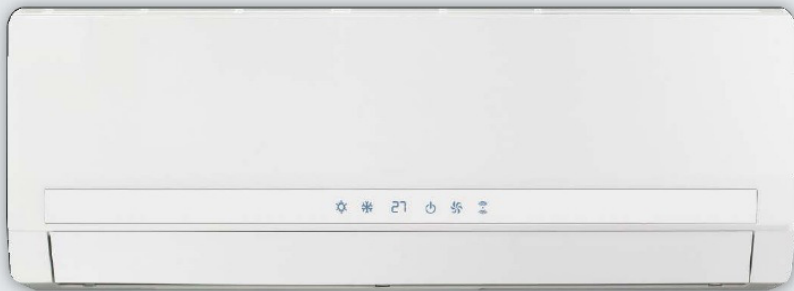

ECODESIGN

ERP COMPLIANT

RoHS

## GUIDA PRODOTTO PRODUCT GUIDE

serie **WF-F**

GP\_WF-F\_22026071-R00

101% MADE IN ITALY  
European core



# VENTILCONVETTORI WALL WALL FAN-COIL UNITS

air treatment  
trattamento dell'aria



serie **WF-F**

**BPS** CLIMA®

- Design raffinato, moderno ed elegante
- Deflettori mandata aria orientabili e motorizzati con diverse posizioni
- Motore AC~230V-Monofase con 3-Velocità (automatiche + manuali)
- Molteplici modalità di funzionamento: automatica, raffreddamento, deumidificazione, ventilazione e riscaldamento
- Timer e molte altre funzioni programmabili con il telecomando
- Regolazione anche con comando remoto a filo
- Sonda minima temperatura acqua
- Scheda elettronica con funzione AUTORESTART
- Morsettiera con uscita per comando di una eventuale elettrovalvola (2 o 3 vie) 230Vac on/off
- Dima di fissaggio in lamiera zincata di forte spessore con fori per il fissaggio a muro
- Filtro aria ad alta efficienza, facilmente estraibile e lavabile
- Funzionamento con temperatura acqua ingresso fino a 80°C

- Beautiful, smart and modern design
- Adjustable and motorised air supply fins with different positions
- AC~230V-single-phase motor with 3-Speed (automatic + manual)
- Several functioning mode: automatic, cooling, dry, ventilation and heating
- Timer and several others programmable functions with the I.R. control
- Control with wired remote control also
- Water low temperature feeler
- Electronic card with AUTORESTART function
- The terminal board is provided with an output to control an eventual electrovalve (2 or 3 way) 230Vac on/off
- The unit is provided with mounting bracket made of extremely thick galvanized steel-sheet with holes enabling wall mounting
- High efficiency air filter, easily removable and cleanable
- Working with water temperature limit 80°C

**UNITÀ AD ACQUA  
WATER UNIT**

**ECODESIGN** **ERP COMPLIANT**

**VENTILCONVETTORI WALL: SEMPLICI, PRATICI, BELLI  
WALL FANCOIL UNITS: SIMPLE, PRATICAL, BEAUTYFUL**

ESP	Qa m³/h	COOL kW	HEAT kW
-----	------------	------------	------------

**serie WF-F** TRADIZIONALE, con motore AC~230V monofase (asincrono), 3-Velocità  
TRADITIONAL, with motor AC~230V single-phase (asynchronous), 3-Speed

<b>AC~230V</b> Tradizionale	/	410÷860	2,3÷4,6	5,1÷10,0
--------------------------------	---	---------	---------	----------

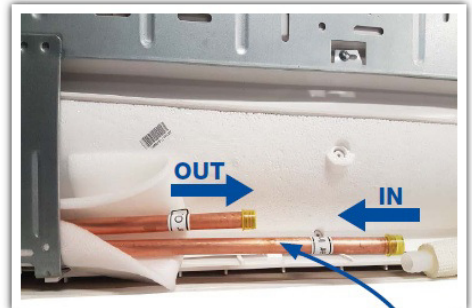
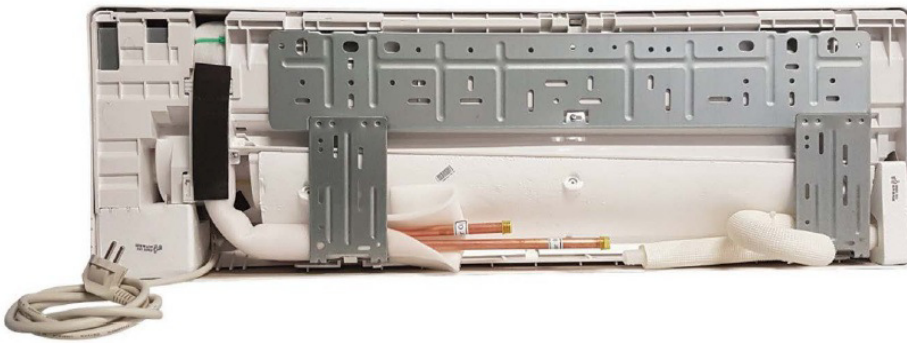

TEL54



CR22



CR25



VL513



VL532



VL522



PMP52

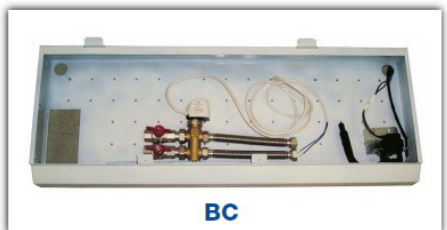

BC



## DESCRIZIONE UNITA' STANDARD

### MOBILE DI COPERTURA (ABS)

Mobile di copertura raffinato, moderno ed elegante, con forme rotondeggianti ed armoniose che ben si inseriscono in qualsiasi ambiente. Costruito in ABS, è resistente alla ruggine, alla corrosione, agli agenti ambientali. Dimensioni molto contenute.

Design con pannello frontale cieco. Colore bianco RAL 9003.

### DEFLETTORI MANDATA ARIA (ORIENTABILI E MOTORIZZATI)

L'apertura e la chiusura delle alette avviene automaticamente con l'accensione e lo spegnimento dell'unità.

Il flusso d'aria può essere regolato manualmente verso destra/sinistra, mentre la regolazione alto/basso è automatica, con oscillazione orizzontale del deflettore, programmabile e bloccabile in qualsiasi posizione tramite il telecomando (il telecomando è un accessorio).

### DIMA DI FISSAGGIO (LAMIERA ZINCATA)

Dima di fissaggio in lamiera zincata di forte spessore con fori per il fissaggio a muro.

### BACINELLA RACCOGLICONDENSA (ABS)

Bacinella raccoglicondensa in ABS provvista di tubo con scarico  $\phi$  16 mm.

### SCAMBIATORE DI CALORE (BATTERIA AD ACQUA)

Batteria di scambio termico in tubo di rame ed alette di alluminio bloccate mediante espansione meccanica.

Attacchi batteria dotati di valvola sfianto aria manuale.

Attacchi idraulici posizionati nella parte bassa, centrali, orientati verso sinistra.

Batterie collaudate alla pressione di 20 Bar, idonee per funzionamento con acqua fino alla pressione max di 10 Bar.

Le batterie sono idonee per funzionamento con acqua calda (caldaia), acqua a bassa temperatura (caldaia a condensazione, pannelli solari, pompa di calore, ecc.), acqua fredda (chiller e/o processi industriali), acqua addizionata con glicole.

Limiti di funzionamento: Max temperatura acqua ingresso +70°C, Min temperatura acqua ingresso +4°C, Min temperatura aria ambiente +4°C.

### GRUPPO VENTILANTE (VENTILATORE TANGENZIALE A 3 VELOCITÀ)

Gruppo ventilante costituito da 1 ventilatore tangenziale direttamente accoppiato al motore elettrico. Montaggio su supporti elastici ed ammortizzatori. Ventilatore equilibrato staticamente e dinamicamente, estremamente silenzioso, appositamente studiato per realizzare elevate portate aria con basso numero di giri RPM (= bassa rumorosità).

Motore elettrico AC~230V a 3-velocità, asincrono monofase a gabbia di scoiattolo, provvisto di protettore termico TH (Klixon), condensatore di marcia sempre inserito, 4 poli, IP42, Classe 130, doppio isolamento.

Costruito secondo le norme internazionali, 230Vac-Ph-50/60Hz.

### FILTRO ARIA (ALTA EFFICIENZA)

Filtro aria facilmente estraibile e rigenerabile mediante lavaggio con acqua, soffiatura, aspirazione. In rete NAN di polipropilene a nido d'ape, ad alta efficienza. Indicato contro Polveri e Pollini.

Classe M1; Grado filtrazione EU2 (EUROVENT 4/5), Group ISO COARSE ePM1=4%, ePM2,5=13%, ePM10=49% (EN ISO 16890:2016).

### EQUIPAGGIAMENTO ELETTRICO (SCHEDE ELETTRONICA E MORSETTIERA)

Scheda elettronica a microprocessore con molteplici funzioni impostabili dal telecomando (il Telecomando è un accessorio).

#### ▪ Sonda minima temperatura acqua inclusa.

▪ Pannello comando a bordo con Interruttore on/off di alimentazione + Pulsante d'emergenza (avvia l'unità con tutte le funzioni in modalità automatica) + 3 Led di indicazione funzionamento ed allarmi.

▪ Morsetti con uscita per comando di una eventuale elettrovalvola (2 o 3 vie) 230Vac on/off.

▪ Scheda elettronica con funzione AUTORESTART: nel caso di interruzione dell'alimentazione elettrica, quando viene alimentata nuovamente riparte nelle condizioni in cui si trovava (mantiene le impostazioni precedentemente impostate perchè dotata di memoria non volatile). Questo consente di realizzare un on/off remoto semplicemente collegando un qualsiasi tipo di dispositivo (orologio, termostato, interruttore, contatto presenza, contatto finestra, ecc.) che interrompa la linea di alimentazione elettrica.

### EVENTUALI ACCESSORI DISPONIBILI: TELECOMANDO

L'unità standard viene fornita senza telecomando.

In questo modo il cliente può scegliere se utilizzare un solo telecomando per controllare più unità, oppure avere un telecomando per ogni singola unità.

Il telecomando controlla le 3 velocità in modo automatico/manuale, ha il Timer e molte altre funzioni programmabili.

## STANDARD UNIT DESCRIPTION

### CABINET (ABS)

Beautiful, smart, modern styled cabinet well-proportioned smoothed outline to perfectly match with any interior decoration.

Made of ABS, it is very resistant to corrosion, rust and environmental agents. Well-balanced proportions.

Design with free surface frontal panel, White colour RAL 9003.

### AIR SUPPLY FINS (ADJUSTABLE AND MOTORIZED)

The fins opening and closing is automatic when the unit starts or stops working.

The airflow can be manually adjusted right/left, while high/low adjustment is automatic, with horizontal deflector swing which can be programmed in any position by infrared remote control (the infrared remote control is an option).

### MOUNTING BRACKET (GALVANIZED STEEL)

The unit is provided with mounting bracket made of extremely thick galvanized steel-sheet with holes enabling wall mounting.

### DRAIN PAN (ABS)

Drain pan made of ABS, provided with drainpipe  $\phi$  16 mm.

### HEAT EXCHANGER (WATER COIL)

Coil made of copper pipes and aluminum fins fixed by mechanical expansion.

Coil connections provided with manual air vent valve.

Water connections positioned in low part, central, in left direction.

Coils tested at 20 Bar pressure, suitable to work with water at max 10 Bar pressure.

Coils designed to work with hot water (boiler), low temperature hot water (condense boiler, solar energy system, hot water pump, etc.), chilled water (chillers and/or industrial processes), water added with glycol.

Working limits: Max inlet water temperature +70°C, Min inlet water temperature +4°C, Min room air temperature +4°C.

### FAN SECTION (3-SPEED TANGENTIAL FAN)

Fan section including 1 tangential fan directly coupled to the electric motor. Mounted on elastic and anti-vibration supports. Fan section statically and dynamically balanced, extra silent fan, designed to realize high airflow with low revolutions number RPM (= low noise level).

3-speeds AC~230V electric motor, asynchronous single-phase squirrel cage, provided with heat protection TH (Klixon), running capacitor permanently switched on, 4 poles, IP42, Class 130, double insulation.

Manufactured according to the international standards, 230Vac-1Ph-50/60Hz.

### AIR FILTER (HIGH EFFICIENCY)

Air filter easy to remove, can be regenerated by water wash, blowing, suction. Made of high efficiency polypropylene NAN cellular fabric net. Superlative against Powders and Pollens.

Class M1; Filtering level EU2 (EUROVENT 4/5), Group ISO COARSE ePM1=4%, ePM2,5=13%, ePM10=49% (EN ISO 16890:2016).

### ELECTRICAL EQUIPMENT (ELECTRONIC CHART AND TERMINAL BOARD)

Electronic card with microprocessor with different functions adjustable with infrared remote control (the Infrared remote control is an option).

#### ▪ Water low temperature sensor included.

▪ Control panel inside the unit with on/off switch supply + Emergency switch (starting the unit with all automatic modes) + 3 Led with indications of operating and alarms.

▪ The terminal board is provided with an output to control an eventual electrovalve (2 or 3 way) 230Vac on/off.

▪ Electronic card with AUTORESTART function: in case the electrical supply is stopped, when restored, the unit restart from the same previous conditions (due to the non-volatile memory the previous settings are kept).

This function enables to realise a simple remote on/off, connecting any device (timer, thermostat, switch, presence contact, windows contact, etc...) interrupting the electric line.

### AVAILABLE ACCESSORIES: INFRARED REMOTE CONTROL

The standard unit is supplied without the I.R. remote control.

In this way the customer can choose to control with the I.R. remote control several units or to have one I.R. remote per each unit.

The I.R. remote control can control 3 speeds in automatic/manual mode.

Timer and several others programmable functions.





## WF-F

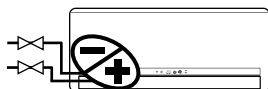
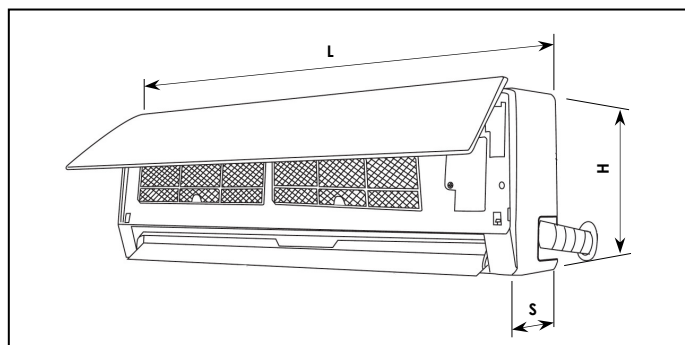
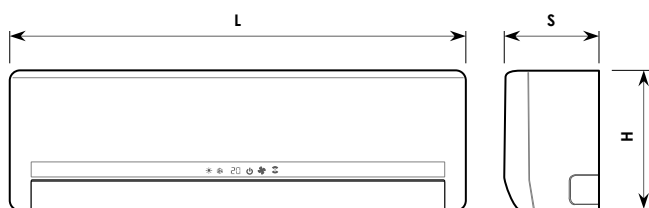

Mod.	WF..F	WF 22F	WF 42F	WF 122F
Potenzialità Frigorifera Totale - Total (1)	W	2.380	2.700	4.600
Cooling capacity Sensibile - Sensible (1)	W	1.850	2.500	3.690
Potenzialità Termica - Heating capacity (2)	W	5.100	6.600	10.000
<b>Portata aria nominale - Nominal Air flow (3)</b>	<b>m³/h</b>	<b>410</b>	<b>560</b>	<b>860</b>
Portata acqua Raffreddamento - Cooling	l/h	409	464	791
Water flow (4) Riscaldamento - Heating	l/h	439	568	860
Perdite di carico acqua Raffreddamento - Cooling	kPa	10,8	17,6	39,5
Water pressure drops (5) Riscaldamento - Heating	kPa	9,7	20,5	36,4
Livelli sonori - Sound levels (6)	Min-Med-Max dB(A)	20 - 24 - 29	21 - 25 - 32	32 - 36 - 39
Ref. FAN-DECK		1x SD100x650, C1-3V, [P1-2-3], [N1-2-3]	1x SD100x650, C1-3V, [P1-2-3], [N1-2-3]	1x SD100x740, C1,5-3V, [P1-2-3], [N1-2-3]
Ref. MOT		AC, 4P, IP42, CI,130, 3V, TH, SCU	AC, 4P, IP42, CI,130, 3V, TH, SCU	AC, 4P, IP42, CI,130, 3V, TH, SCU
Numero Ventilatori/Motori - Fans/Motors number	No./No.	1 / 1	1 / 1	1 / 1
Numero velocità - Speed number	No.	3	3	3
Assorbimento elettrico nominale (Targa)	MAX(7) W	30 W	37 W	50 W
Nominal current input (Label)	MAX(7) A	0,13 A	0,16 A	0,22 A
<b>Alimentazione elettrica - Power supply</b>		<b>230Vac-1Ph-50/60Hz</b>		<b>230Vac-1Ph-50/60Hz</b>
Dimensioni	L mm	850	850	940
Dimensions	H mm	270	270	300
	S mm	180	180	200
Batteria caldo/freddo Contenuto acqua - Water volume (l)		0,81	0,83	1,44
Heating/cooling coil Ranghi - Rows No.		3R	3R	3R
Attacchi idraulici - Water connections DN(*)		DN.12 mm (ext.)	DN.12 mm (ext.)	DN.12 mm (ext.)
Scarico condensa - Drain pipe	φ (mm)	16	16	16
Peso netto - Net weight	kg	10,5	11,0	13,0
<b>Riduzione Portata Aria</b> <b>Air Flow Reduction (8)</b>	Max	1,00	1,00	1,00
	Med	0,80	0,80	0,88
	Min	0,66	0,66	0,69
<b>Accessori raccomandati - Recommended Accessories</b>		<b>Telecomando - I.R.control (TEL54)</b>		
	Cod.	160022005	160042005	160122005



### (9) RIDUZIONE POTENZIALITÀ FRIGORIFERA/TERMICA (in funzione della riduzione portata aria) COOLING/HEATING CAPACITY REDUCTION (depending on air flow reduction)

Portata aria - Air flow	1,00	0,95	0,90	0,85	0,80	0,75	0,70	0,65	0,60	0,55	0,50	0,45	0,40	0,35	0,30	0,25	0,20	0,15	0,10
Potenz. Frigorifera Totale - Total	1,00	0,97	0,95	0,92	0,89	0,87	0,84	0,81	0,77	0,74	0,71	0,67	0,63	0,59	0,55	0,50	0,45	0,39	0,32
Cooling capacity Sensibile - Sensible	1,00	0,97	0,93	0,90	0,86	0,83	0,79	0,76	0,72	0,68	0,64	0,60	0,55	0,51	0,46	0,41	0,35	0,29	0,22
Potenz. termica - Heating capacity	1,00	0,97	0,94	0,91	0,87	0,84	0,81	0,77	0,74	0,70	0,66	0,62	0,58	0,53	0,49	0,44	0,38	0,32	0,25

DN(\*) = Diametro nominale (Tubo rame D.12mm ext.)

Dati tecnici riferiti alle seguenti condizioni: Unità Standard - Pressione atmosferica 1013 mbar - Alimentazione elettrica 230Vac/1Ph/50Hz.

(1) (2) (4) (5): Dati tecnici nominali, rif. portata aria nom. (3) @ V max, ESP=0, batteria asciutta → Per le prestaz. (1) (2) alla portata aria di funzionamento riferirsi a B+9 o al SW.

(1) Raffreddamento: Temp. aria 27°C db, 19°C wb - Temp. acqua ingresso/uscita 7/12°C - Portata aria nominale (3). Per le portate aria di funzionamento (es. alle diverse Vel. Max/Med/Min e/o diverse ESP) vedi (8) (9); rif. acqua ing. 7°C e portata acqua nominale (4). Raccomandato uso del SW.

(2) Riscaldamento: Temp. aria 20°C - Temp. acqua ingresso/uscita 70/60°C - Portata aria nominale (3). Per le portate aria di funzionamento (es. alle diverse Vel. Max/Med/Min e/o diverse ESP) vedi (8) (9); rif. acqua ing. 70°C e portata acqua nominale (4). Raccomandato uso del SW.

(1) (2) (9) Resa Frigorifera e Termica: Valori calcolati da SW e coll. rilevati in camera calorimetrica rif. norme UNI 7940 parte 1° e 2°, UNI-EN 1397/2001.

(3) (8) Portata aria e Press. statica: Valori nominali rilevati con cassone rif. norme AMCA210-74 fig.12 e condotto + diaframma rif. norme CNR-UNI10023.

(4) Livelli sonori: Pressione sonora in campo libero, distanza 2 m. Valori calcolati da potenza sonora rilevata in camera riverberante rif. norme ISO 3741 - ISO 3742.

(7) Dati elettrici: Valori rilevati con Wattmetro Jolegowa WT110 (Valore max. nominale, di targa motore = valore di riferimento per progettazione impianto elettrico). Per gli assorbimenti elettrici in funzionamento, classi efficienza energetica, ecc. vedi paragrafo "Tab Regolamento UE-2014-2281".

DN(\*) = Nominal diameter (Copper pipe D.12mm ext.)

Technical data refer to the following conditions: Standard unit - Atmospheric pressure 1013 mbar - Power supply 230Vac/1Ph/50Hz.

(1) (2) (4) (5): Nominal technical data, refer to the nominal air flow (3) @ V max, ESP=0, dry coil → For the performances (1) (2) in the operating air flow ref. B+9 or the SW.

(1) Cooling: Air temp.: 27°C db, 19°C wb, - Entering/leaving water temp. 7/12°C - Nominal air flow (3). For the operating air flows (ex. at the different Speed Max/Med/Min and/or different ESP) see (8) (9); ref. entering water temp. 7°C and nominal water flow (4). Recommended use of the SW.

(2) Heating: Air temp.: 20°C - Entering/leaving water temp. 70/60°C - Nominal air flow (3). For the operating air flows (ex. at the different Speed Max/Med/Min and/or different ESP) see (8) (9); ref. entering water temp. 70°C and nominal water flow (4). Recommended use of the SW.

(1) (2) (9) Cooling and Heating capacities: Data calculated by SW and measurements made in calorimetric room ref. UNI 7940 part 1°-2°, UNI-EN 1397/2001 standards.

(3) (8) Air flow and static pressure: Nominal data measured with casing ref. AMCA210-74 fig.12 standards and plenum + diaphragm ref. CNR-UNI10023 standards.

(4) Sound Levels: Free field sound pressure, 2 m distance. Data calculated based on sound power measured in reverberation room ref. ISO 3741 - ISO 3742 standards.

(7) Electrical data: Data measured with Wattmeter Jolegowa WT110 (Max value, nominal, of motor label = reference value for the electrical system design). For the operating electrical power absorption, energy efficiency class, etc. see paragraph "Tab UE-2014-2281 Regulation".

L'unità standard viene fornita completa di scheda elettronica a microprocessore predisposta per il controllo tramite telecomando.  
L'unità standard viene però fornita senza telecomando: in questo modo il cliente può scegliere se utilizzare un solo telecomando per controllare più unità, oppure avere un telecomando per ogni singola unità (1 solo telecomando può comandare più unità).  
Con il telecomando si possono controllare a distanza tutte le funzioni dell'unità: on/off, impostazione del set-point, selezione velocità ventilatore (3 velocità manuali/automatiche), posizionamento deflettori (manuali/automatiche), modalità funzionamento (manuale/automatico, Raffreddamento, Deumidificazione, Ventilazione, Riscaldamento), programmazione giornaliera, ecc.

The standard unit is supplied with electronic card with microprocessor with different functions adjustable with infrared remote control.  
The standard unit is supplied without the I.R. remote control: in this way the customer can choose to control with the I.R. remote control several units or to have one I.R. remote per each unit.  
With infrared remote all functions can be controlled: on/off, set-point adjust, fan speed selection (3 speed + autom.), air supply fins positioning (manual/automatic), operating mode (Cooling, Drying, Ventilation, Heating + Automatic), daily programming, etc.



**TEL54**

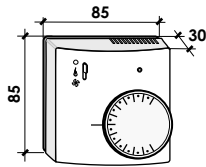

**TR1** Solo termostato  
Thermostat only

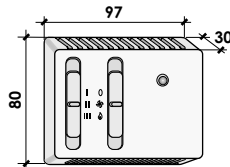

**CR1** Solo 3-Velocità  
3-Speed only

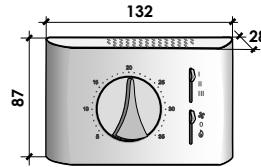

**CR22** 3Vel. Manuali  
Manual 3speed

**CR23** 3Vel. Manuali/Auto  
Manual/Auto 3speed

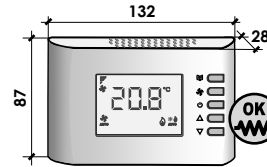

**CR25** MOT\_AC-230V  
+ VL\_ON/OFF, PWM, 3-Point

**CR26** MOT\_AC-230V + VL- M010 (0...10Vdc)  
opp./or:  
MOT\_EC-230V + VL-230V (on/off) or VL-M010 (0...10Vdc)

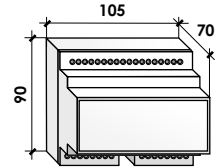

**SDI.4x3A**



Mod.

Cod.

### REGOLAZIONE TRAMITE TELECOMANDO - REGULATION WITH I.R. CONTROL

<b>TEL 54</b>	Telecomando a raggi infrarossi e display a cristalli liquidi (multifunzionale/programmabile) - Colore bianco Infrared remote control with LC display (Multi-functions/programmable) - White colour (TEL54: Accessorio fornito non montato - Accessory supplied not mounted), (Compatibilità/y WF 22/42/122/F)	169901005
---------------	---	-----------

### REGOLAZIONE TRAMITE COMANDO REMOTO A FILO - REGULATION WITH WIRE REMOTE CONTROL

<b>PXCR</b>	Predisposizione per controllo unità tramite comando remoto (in questo caso il comando alette diventa solo manuale). Consiste nel fornire le unità con una opportuna morsettiere adatta per il collegamento a qualsiasi comando remoto a filo (in azienda viene tolta la scheda telecomando ed installati: Morsettiere MRS1 + Condensatore C + Autotrasformatore AUTR).  Arrangement for the unit control with remote (in this case the louvers control becomes only manual). It consists on supplying the unit with terminal board suitable to connect the unit to any remote control (in the factory the electronic card is put out and is installed: Terminal board MRS1 + Capacitor C + Autotransformer AUTR).	169906002
-------------	---	-----------

### TERMOSTATI ELETTRONICI (NO GESTIONE 3-VELOCITA') - ELECTRONIC THERMOSTATS (NO 3-SPEED CONTROL)

<b>TR1</b>	Termostato ambiente 230Vac, con OFF/Est/Inv (1 contatto in scambio, con inversione logica HEAT/COOL) Room thermostat 230Vac, with OFF/Summer/Winter (1 contact change-over, with reverse HEAT / COOL logic) (Contatti-Contacts: 1SPDT-co 5(1)A@250Vac), (Compatibilità/y: SND-A)	089905001
------------	--	-----------

### COMANDI VELOCITA' ELETTRONICI (NO-TERMOSTATO) - ELECTRONICS SPEED-CONTROLS (NO-THERMOSTAT)

<b>CR1</b>	Comando 230Vac con OFF/Est/Inv + 3 Velocità, senza termostato (gestione delle sole 3-velocità di unità AC-230V, NO valvole) Control 230Vac with OFF/Summer/Winter + 3 Speed, without thermostat (only 3-speed control of AC-230V units, NO valves) (Ventilatore-Fan AC: 5,0A@250Vac), (Compatibilità/y: TM-32, TM-42)	089905011
------------	---	-----------

### COMANDI VELOCITA' ELETTRONICI CON TERMOSTATO - ELECTRONICS SPEED-CONTROLS WITH THERMOSTAT

<b>CR22</b>	Comando 230Vac con OFF/Est/Inv + 3 Velocità + Termostato (gestione unità AC-230V 2-4 tubi, con/senza valvole VL-230V) Control 230Vac with OFF/Summer/Winter + 3 Speed + Thermostat (control 2-4 pipe AC-230V units, with/without valves VL-230V) (Ventilatore-Fan AC: 5(1)A@250Vac, Valvole-Valves: 1A@230Vac), (Compatibilità/y: TM-32, TM-42, SND-A4)	089905035
<b>CR23</b>	Comando 230Vac con OFF/Est/Inv + 3Vel. manuali/auto + Anti-stratificazione + Termostato (gestione unità AC-230V 2-4 tubi, con/senza valvole VL-230V) Control 230Vac with OFF/Summer/Winter + 3 Speed manual/auto + Anti-stratification + Thermostat (control 2-4 pipe AC-230V units, with/without valves VL-230V) (Ventilatore-Fan AC: 3(1)A@250Vac, Valvole-Valves: 1A@230Vac), (Compatibilità/y: SND-W4, TM-32, TM-42, SND-A4)	089905036

### REGOLATORI ALTO LIVELLO, A MICROPROCESSORE, CONFIGURABILI/MULTIFUNZIONE, REGOLAZIONE MODULANTE P, P+ HIGH LEVEL CONTROLLERS, MICROPROCESSOR, CONFIGURABLE/MULTIFUNCTIONS, REGULATION MODULATING P, P+

<b>CR25</b>	Gestione unità 2-4 tubi con/senza valvole. Uscite: 1 motore AC-230V 1...3Vel. + 2 valvole ON/OFF, PWM, 3-Punti (es. VL-230V, VL-F230) Control 2-4 pipes unit with/without valves. Output: 1 AC-230V motor 1...3-Speed + 2 valves ON/OFF, PWM, 3-Point (ex. VL-230V, VL-F230) (Ventilatore-Fan AC: 3A@230Vac, Valvole-Valves: 0,3A@230Vac), (Compatibilità/y: SND-W4, TM-32, TM-42, SND-A4)	089905037
<b>CR26</b>	Gestione unità 2-4 tubi. Uscite: 1 motore AC-230V 1...3Vel. + 2 valvole modulanti 0...10Vdc (es. VL-M010). Oppure 1 motore EC-230V 0...10Vdc (es. Brush) + 2 valvole modulanti 0...10Vdc (es. VL-M010) o 2 valvole ON/OFF, PWM (es. VL-230V opp. 1VL+1RES) Control 2-4 pipes unit. Output: 1 AC-230V motor 1...3-Speed + 2 modulating valves 0...10Vdc (ex. VL-M010), Or electronic EC-230V motor 0...10Vdc (ex.: Brushless) + 2 modulating valves 0...10Vdc (ex. VL-M010) or 2 valves ON/OFF, PWM (ex. VL-230V or 1VL+1RES) (Ventilatore-Fan AC: 3(1)A@250Vac, Output EC 0...10Vdc: 3x1850Q), (Compatibilità/y: SND-W4, TM-32, TM-42, SND-A4)	089905038

### SCHEDA DI INTERFACCIA, SONDE E TERMOSTATI TEMPERATURA ACQUA - INTERFACE CARD, TEMPERATURE SENSORS AND THERMOSTAT

<b>SDI.4x3A</b>	Scheda con 4 uscite da 3A (idonea per controllare fino a max n° 4 motori 3-Velocità da 3A; es. n°4 piccoli fan-coils) Card with 4 by 3A output (suitable to control up to max No. 4 3-Speed 3A motors; ex. No. 4 small fan-coils) (Contatti-Contacts: 4x 3(0,3)A@250Vac), (Solo per unità AC-230V-3Vel. - Only for AC-230V-3Speed)	089905031
<b>SND-W4</b>	Sonda temp. acqua (in alternativa al termostato "TM") - Water temperature sensor (alternative to "TM" thermostat. NTC 10KΩ, L=600mm) Compatibilità/y: (CBE25, CBE26), (CR23, CR25, CR26)	089905043
<b>TM-32</b>	Termostato minima temperatura acqua calda "TM" - Minimum hot water temperature thermostat "TM"	T.SET = 32°C 089902001
<b>TM-42</b>	Compatibilità/y: (CBE21, CBE22, CBE23, CBE25, CBE26, CBE27), (CB2, CB4), (CR1, CR22, CR23, CR25, CR26)	T.SET = 42°C 089902005

- TM con T.SET=32°C: Consigliato per acqua calda a bassa temperatura (es. pompa di calore)
- TM con T.SET=42°C: Consigliato per acqua calda ad alta temperatura (acqua IN fino a 60°C)

#### CR1...CR26: COMANDI REMOTI PIU' USATI (forniti non montati)

Per unità AC-230V: 1 pannello comandi può controllare 1 sola unità (vedi accessorio "SDI")  
Per ulteriori informazioni tecniche e Modalità di funzionamento dei comandi esposti (+ disponibilità di ulteriori comandi), vedi sezione "Regolazione" (REG).

- TM with T.SET=32°C: Recommended with low temperature hot water (ex. heat pump)
- TM with T.SET=42°C: Recommended with high temperature hot water (water IN up to 60°C)

#### CR1...CR26: MOST COMMON REMOTE CONTROLS (supplied not mounted)

For AC-230V unit: 1 control panel can control only 1 unit (see accessory "SDI")  
For further Technical and Operating information about the shown controls (+ further available controls), see "Regulation" (REG) section.

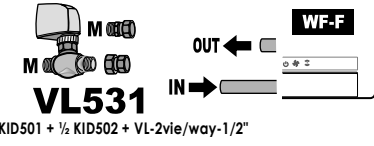
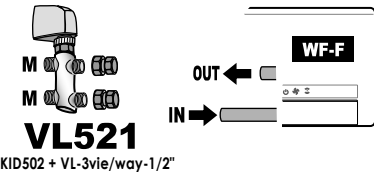
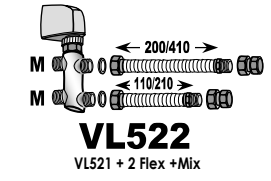
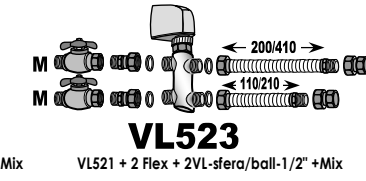
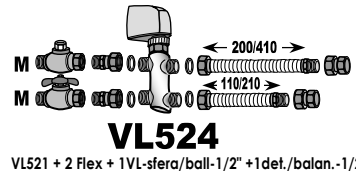
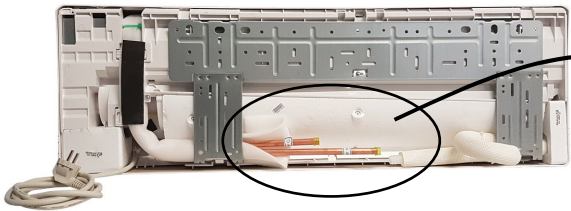
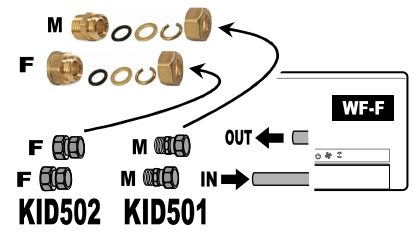
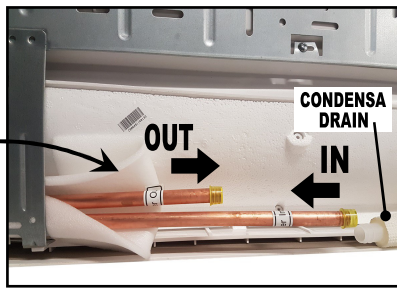
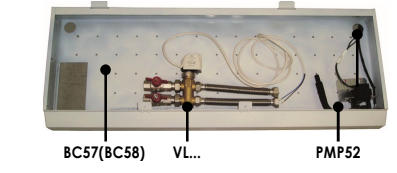
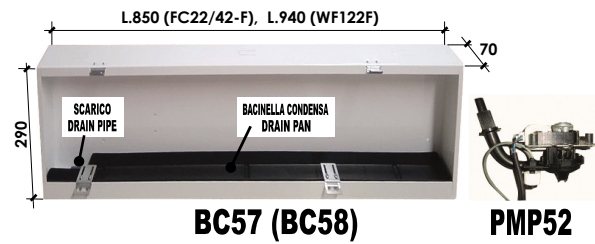

Mod.	Accessori forniti non montati sull'unità - Accessories supplied not mounted on the unit	Cod
<b>BC 57</b>	(1) Cornice/Bacinella raccoglicondensa INCASSO/ESTERNO. Spessore 70mm, Colore bianco RAL 9002 RECESSED/EXTERNAL Case/Drain pan. Thickness 70mm, White colour RAL 9002	Compatibilità/y: WF22F, WF42F 169902012
<b>BC 58</b>	(1) Cornice/Bacinella raccoglicondensa INCASSO/ESTERNO. Spessore 75mm, Colore bianco RAL 9002 RECESSED/EXTERNAL Case/Drain pan. Thickness 75mm, White colour RAL 9002	Compatibilità/y: WF122F 169902016
<b>PMP52</b>	Pompa condensa 230Vac (Portata acqua max 10 l/h ; Prevalenza 6,0 m.c.a. ; Aspirazione max 2,5 m.c.a.) Condensate pump 230Vac (Max water flow 10 l/h ; Max discharge head 6.0 m.w.c. ; Max suction head 2.5 m.w.c.)	169903002
<b>KID501</b>	2 Raccordi a stringere in ottone, tenuta con o-ring in NBR, per tubo rame D.12 ext., attacco lato utente 1/2" Gas Maschio 2 Brass fittings, sealing by NBR o-ring, for copper pipe D.12 ext., user side connection Gas Male 1/2"	169904000
<b>KID502</b>	2 Raccordi a stringere in ottone, tenuta con o-ring in NBR, per tubo rame D.12 ext., attacco lato utente 1/2" Gas Femmina 2 Brass fittings, sealing by NBR o-ring, for copper pipe D.12 ext., user side connection Gas Female 1/2"	169904001
<b>VL513</b>	KID501 + 2 Valvole a sfera DN 1/2" (Kv=14,6) // KID501 + 2 Shut-off (ball) DN1/2" (Kv=14,6) valves	169904002
<b>VL514</b>	KID501 + 1 Valvola a sfera DN 1/2" (Kv=14,6) + 1 Detentore DN 1/2" (Kv=2,5) // KID501 + 1 Shut-off (ball) DN1/2" (Kv=14,6) valve + 1 Balancing DN1/2" (Kv=2,5) valve	169904003

(1) Bacinella con supporto di sostegno e sede per valvola a 2 o 3 vie e pompa scarico condensa (Valvola e Pompa non compresi: essi sono altri accessori). In lamiera zincata + verniciata a polveri epossidiche, provvista di scarico inferiore (per deflusso per gravità) + 2 superiori (se si installa la pompa condensa).

(1) Drain pan with supporting template for 2 or 3-way valve and drain pump housing (Valve and Pump not included; optional items). Made of galvanized steel + painted by epossidic powder, provided with lower drain pipe (gravity drainage) + 2 higher drain pipe (if the drain pump is installed).

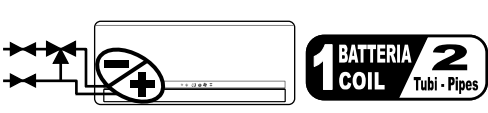

Per batteria caldo/freddo (unità 2-tubi) - For cooling/heating coil (2-pipe unit)									
3-vie / 3-way					2-vie / 2-way				
N° 1 valvola 3 vie (4 attacchi) No. 1 3-way valve (4 connections)					N° 1 valvola 2 vie (2 attacchi) No. 1 2-way valve (2 connections)				
DN 1/2" M - Kv 1,7 - PN 16 Bar					DN 1/2" M - Kv 1,7 - PN 16 Bar				
DN 1/2" M					DN 1/2" M				
<b>Mod. generale/padre - Father/general Mod. (2)</b>		<b>VL521</b>	<b>VL522</b>	<b>VL523</b>	<b>VL524</b>	<b>VL531</b>	<b>VL532</b>	<b>VL533</b>	<b>VL534</b>
<b>VL-230V</b>	<b>PWM &amp; ON/OFF (230V)</b> Elettrotermico - Electrothermic (230Vac, 50-60Hz)	Mod. Cod. VL521-230V 169905001	Mod. Cod. VL522-230V 169905002	Mod. Cod. VL523-230V 169905003	Mod. Cod. VL524-230V 169905004	Mod. Cod. VL531-230V 169905101	Mod. Cod. VL532-230V 169905102	Mod. Cod. VL533-230V 169905103	Mod. Cod. VL534-230V 169905104
<b>VL-24V</b>	<b>PWM &amp; ON/OFF (24V)</b> Elettrotermico - Electrothermic (24Vac, 50-60Hz)	Mod. Cod. VL521-24V 169905011	Mod. Cod. VL522-24V 169905012	Mod. Cod. VL523-24V 169905013	Mod. Cod. VL524-24V 169905014	Mod. Cod. VL531-24V 169905111	Mod. Cod. VL532-24V 169905112	Mod. Cod. VL533-24V 169905113	Mod. Cod. VL534-24V 169905114
<b>VL-F24</b>	<b>3 Punti/Points 24V</b> Flottante - Floating (24Vac, 50-60Hz)	Mod. Cod. VL521-F24 169905021	Mod. Cod. VL522-F24 169905022	Mod. Cod. VL523-F24 169905023	Mod. Cod. VL524-F24 169905024	Mod. Cod. VL531-F24 169905121	Mod. Cod. VL532-F24 169905122	Mod. Cod. VL533-F24 169905123	Mod. Cod. VL534-F24 169905124
<b>VL-F230</b>	<b>3 Punti/Points 230V</b> Flottante - Floating (230Vac, 50-60Hz)	Mod. Cod. VL521-F230 169905031	Mod. Cod. VL522-F230 169905032	Mod. Cod. VL523-F230 169905033	Mod. Cod. VL524-F230 169905034	Mod. Cod. VL531-F230 169905131	Mod. Cod. VL532-F230 169905132	Mod. Cod. VL533-F230 169905133	Mod. Cod. VL534-F230 169905134
<b>VL-M010</b>	<b>Modulante/Modulating 0-10V</b> Alimentazione/Power : 24 Vac, 50-60Hz Segnale modulazione - Modulating signal: 0...10V	Mod. Cod. VL521-M010 169905041	Mod. Cod. VL522-M010 169905042	Mod. Cod. VL523-M010 169905043	Mod. Cod. VL524-M010 169905044	Mod. Cod. VL531-M010 169905141	Mod. Cod. VL532-M010 169905142	Mod. Cod. VL533-M010 169905143	Mod. Cod. VL534-M010 169905144

(1) DN= Diametro Nominale, M= Attacchi idraulici Gas Maschio, F= Attacchi idraulici Gas Femmina PN= Pressione nominale valvola; Kv= Fattore perdita di carico acqua valvola

(1) DN= Nominal Diameter, M= Male Gas water connections, F= Female Gas water connections PN= Valve nominal pressure; Kv= Valve water pressure drop factor

(2) Ogni singolo Kit valvole "VL..." è compatibile con qualsiasi taglia di unità WF-F  
 • La Valvola viene fornita non montata. È possibile montarla solo all'esterno dell'unità (sull'impianto) o all'interno della Bacinella/Cornice BC57, BC58 (accessori).  
 • La scheda telecomando standard dell'unità è in grado di controllare solo una valvola VL-230V.  
 • VL-24V; VL-F24; VL-F230; VL-M010: Valvole non controllabili dalla scheda telecomando standard dell'unità. Per la loro regolazione, obbligatorio accessorio PXR + adeguato regolatore (es. CR25-CR26).  
 • Il "Kit montaggio" comprende tutti i componenti necessari per il montaggio della valvola di regolazione sull'unità: kit come da figura indicata, incluso guarnizioni, ecc.

(2) Each "VL..." valve kit is suitable for any unit WF-F size  
 • The valve is supplied not mounted. It can be mounted only outside the unit (on the pipe system) or inside the Case/Drain pan BC57, BC58 (accessories).  
 • The standard I.R. card of the unit is suitable to controlled only one VL-230V valve.  
 • VL-24V; VL-F24; VL-F230; VL-M010: Valves not controllable by the standard I.R. card of the unit. For their regulation, PXR accessory is compulsory + suitable controller (ex. CR25-CR26).  
 • The "Installation Kit" include all necessary components to mount the regulation valve on the unit: kit as shown in the figure, included gaskets, etc.

**Valvola a 3 vie:** consigliata per impianti con tradizionale pompa a portata acqua costante.  
**Valvola a 2 vie:** consigliata per impianti con pompa a risparmio energetico (pompa con RPM variabile, che garantisce portata acqua variabile e prevalenza costante).

**3 way valve:** is recommended with systems provided with traditional constant water flow pump.  
**2 way valve:** is recommended with systems provided with energy saving pump (pump with variable RPM, able to guarantee variable water flow and constant pressure).

Escluso il Sistema di Regolazione (regolatore, sonde, schede elettroniche, ecc.). I Kit valvole sono compatibili con qualsiasi sistema di regolazione (Johnson Controls, Honeywell, Siemens, ecc.).  
 VL-24V, VL-F24, VL-M010: Escluso Trasformatore 230V-24V (disponibile come accessorio addizionale)

Regulating system not included (regulator, sensors, electronic interface charts, etc.). The valve kits are compatible with any regulation system (Johnson Controls, Honeywell, Siemens, etc...).  
 VL-24V, VL-F24, VL-M010: Transformer 230V-24V not included (available as additional accessory)



Versioni disponibili  
Available versions



Freddo - Cooling 1,0 ÷ 10,7 kW  
Caldo - Heating 2,5 ÷ 23,3 kW  
Portata aria - Air flow 200 ÷ 1.950 m³/h



Freddo - Cooling 2,9 ÷ 15,2 kW  
Caldo - Heating 7,0 ÷ 30,0 kW  
Portata aria - Air flow 530 ÷ 2.280 m³/h



Freddo - Cooling 2,3 ÷ 4,6 kW  
Caldo - Heating 5,1 ÷ 10,0 kW  
Portata aria - Air flow 410 ÷ 860 m³/h



Freddo - Cooling 6,0 ÷ 20,3 kW  
Caldo - Heating 13,1 ÷ 40,9 kW  
Portata aria - Air flow 1.100 ÷ 3.130 m³/h



Freddo - Cooling 6,8 ÷ 25,7 kW  
Caldo - Heating 15,2 ÷ 54,0 kW  
Portata aria - Air flow 1.350 ÷ 4.450 m³/h



Freddo - Cooling 5,2 ÷ 94,0 kW  
Caldo - Heating 13,0 ÷ 188,0 kW  
Portata aria - Air flow 1.500 ÷ 12.000 m³/h



Freddo - Cooling 5,2 ÷ 648,0 kW  
Caldo - Heating 13,6 ÷ 1.204,0 kW  
Portata aria - Air flow 1.500 ÷ 80.000 m³/h



Freddo - Cooling 5,8 ÷ 40,4 kW  
Caldo - Heating 15,2 ÷ 106,4 kW  
Portata aria - Air flow 1.700 ÷ 8.870 m³/h



Portata aria - Air flow 500 ÷ 60.000 m³/h  
Pressione statica  
Static pressure 50 ÷ 2.000 Pa



Caldo - Heating 14,0 ÷ 1.400,0 kW  
Portata aria - Air flow 800 ÷ 80.000 m³/h



Caldo - Heating 14,0 ÷ 33,0 kW  
Portata aria - Air flow 840 ÷ 2.500 m³/h



Caldo - Heating 14,0 ÷ 33,0 kW  
Portata aria - Air flow 840 ÷ 2.500 m³/h



Caldo - Heating 23,0 ÷ 34,0 kW  
Portata aria - Air flow 1.700 ÷ 2.540 m³/h



Caldo - Heating 14,0 ÷ 151,0 kW  
Portata aria - Air flow 800 ÷ 8.600 m³/h



Caldo - Heating 20,4 ÷ 109,3 kW  
Portata aria - Air flow 2.500 ÷ 9.200 m³/h



Portata aria - Air flow 3.600 ÷ 7.200 m³/h



APPENDICE  
APPENDIX

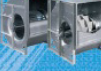

APPENDICE  
APPENDIX



APPENDICE  
APPENDIX



APPENDICE  
APPENDIX



APPENDICE  
APPENDIX



APPENDICE  
APPENDIX



## FC

Ventilconvettori  
Fan-coil units

## CW

Cassette ad acqua  
Water cassette units

## WF-F

Ventilconvettori Wall  
Wall Fan-coil units

## CPR

Canalizzabili Piatte/Ribassate (modulari)  
Terminal Units Slim/Reduced (modular)

## CPM

Canalizzabili Piatte/Medie (modulari)  
Terminal Units Slim/Medium (modular)

## UTM

Unità Canalizzabili Medie (modulari)  
Medium Terminal Units (modular)

## UTB

Termoventilanti Big (modulari)  
Big Thermo-ventilating Units (modular)

## ATR

Aerotermi  
Aerotherms

## CVT

Cassonetti ventilanti  
Ventilating boxes

## GG

Generatori aria calda e Moduli energetici  
Air heaters and Energy module

## GG-D

Generatori aria calda a basamento (gasolio)  
Floor standing air heaters (oil)

## GG-GAS

Generatori aria calda a basamento (gas)  
Floor standing air heaters (gas)

## GG-K

Generatori aria calda pensili (piccola potenza)  
Wall air heaters (small power)

## GG-KX

Generatori aria calda pensili (grande potenza)  
Wall air heaters (big power)

## BA

Barriere aria (industriali)  
Air barriers (industrial)

## DT

Destratificatori (industriali)  
Destratifiers (industrial)

## MOTORIZ

Motorizzazioni  
Motorizations

## ELECTR

Dispositivi Elettrici & Quadri elettrici  
Electrical devices & Electric boards

## REG

Regolazione & Comandi remoti  
Regulation & Remote controls

## WATER

Dispositivi ed Accessori lato idraulico  
Water side devices and accessories

## AIR

Serrande aria & Dispositivi aeraulici  
Air dampers & Aeraulic devices

## APPENDIX

Tabelle conformità Regolamento UE  
Tables conformity Regulation EU





air treatment  
trattamento dell'aria

Richiedi il nostro catalogo prodotti e listino prezzi completo  
Please ask for our complete catalogue and price list



Tel. +39 0422-445363 r.a.



Fax +39 0422-398646



e-mail: [info@bpstecnologie.com](mailto:info@bpstecnologie.com)



[www.bpstecnologie.com](http://www.bpstecnologie.com)  request password

**BPS**   
CLIMA®

BPS S.r.l. - Zona Industriale Biban, 56 - 31030 Carbonera (TV) - Italy  
Tel.: +39 0422-445363 r.a. - Fax.: +39 0422-398646  
[www.bpstecnologie.com](http://www.bpstecnologie.com) - e-mail: [info@bpstecnologie.com](mailto:info@bpstecnologie.com)